

DATE DRAWN: 01/07/25

INSERT REV TABLE BELOW

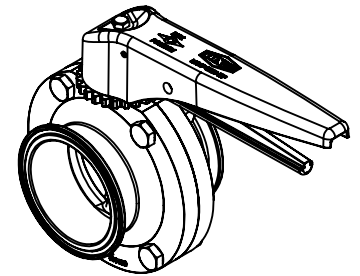
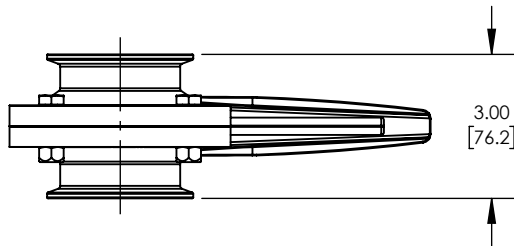
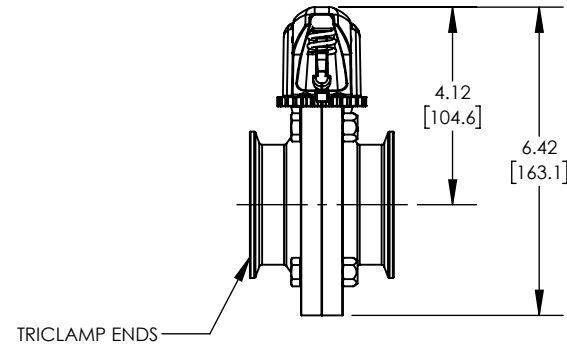
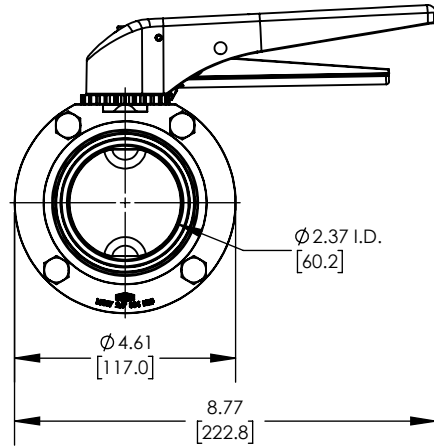

**DRAWING
NOT TO SCALE**

UNITS: IN [MM]	PRODUCT CONTACT MAX. SURFACE FINISH: 32Ra	WEIGHT: 4.18 Lb	MATERIAL: AISI 304 (1.4301)	DRAFTER: GRP
----------------	---	-----------------	-----------------------------	--------------

DESCRIPTION:
**2-1/2" L5107 BUTTERFLY VALVE, SILICONE,
 TRICLAMP ENDS, PLASTIC TRIGGER HANDLE**

PART #
L5107S250CC-P

PROPRIETARY AND CONFIDENTIAL

THIS DRAWING IS OWNED BY DIXON VALVE & COUPLING CO. AND SHALL BE RETURNED UPON DEMAND. IT IS LOANED ON CONDITION THAT IT SHALL NOT BE COPIED OR REPRODUCED OR SUBMITTED TO OTHERS WITHOUT THE OWNER'S CONSENT. IN ACCEPTING IT SUBJECT TO THIS CONDITION THE RECIPIENT FURTHER AGREES THAT THIS DRAWING OR ANY DESIGN DETAIL OR CONCEPT DISCLOSED HEREIN SHALL NOT BE USED IN ANY WAY DETRIMENTAL TO OR IN COMPETITION WITH THE OWNER. IF THE RECIPIENT DOES NOT AGREE TO THE TERMS OF THIS AGREEMENT THEY SHALL RETURN THIS DRAWING IMMEDIATELY. THE INFORMATION CONTAINED IN THIS DRAWING IS SUBJECT TO CHANGE WITHOUT NOTICE.



The Right Connection®